

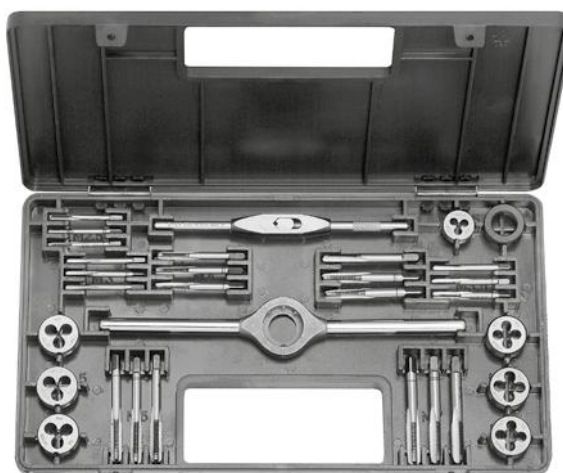





M 0-II**NO****HSS**

Souprava závitorezných nástrojů
Tap & die set
Gewindeschneidwerkzeug-Satz
Набор для нарезания резьбы



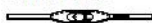



**M**

Norma / Standard / Norm / Norma		Norma / Standard / Norm / Norma		kg	axbxc	code
ČSN 22 3010 	M 2,5; 3; 3; 5; 4; 5; 6; 7	ČSN 24 1521 	Ø 20 / Ø 16 mm	0,65	255x140x22	NO/CS/WS 310 070
DIN EN 22 568 	M 2,5; 3; 3; 5; 4; 5; 6; 7	ČSN 24 1126 	2-4,5 mm	0,65	255x140x22	HSS 340 070
ČSN 24 1520 	Ø 20 mm					

M 1-II**NO****HSS**

Souprava závitorezných nástrojů
Tap & die set
Gewindeschneidwerkzeug-Satz
Набор для нарезания резьбы

**M**

Norma / Standard / Norm / Norma		Norma / Standard / Norm / Norma		kg	axbxc	code
ČSN 22 3010 	M 3; 4; 5; 6; 8; 10; 12	ČSN 24 1521 	Ø 25 / Ø 20 mm Ø 38 / Ø 30 mm	2,15	345x200x32	NO/CS/WS 310 120
DIN EN 22 568 	M 3; 4; 5; 6; 8; 10; 12	ČSN 24 1126 	2,5-7,1 mm	2,15	345x200x32	HSS 340 120
ČSN 24 1520 	Ø 25; 38 mm			2,15	345x200x32	HSS LH*) 350 120



BUČOVICE
TOOLS a.s.

Materiál: NO; HSS
*) levé provedení

Material: CS; HSS
*) left thread

Werkstoff: WS; HSS
*) Gewindelinks

Материал: NO; HSS
*) левая резьба